

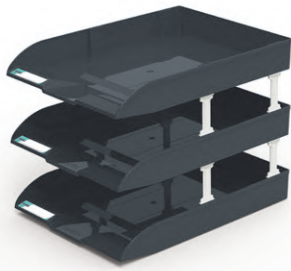

Documents & Parts Cabinet / Bin

Documents Cabinet

Documents Tray



TOA-14

W260xD350xH265

3pcs Pack

Documents Cabinet



PS material



Colored label

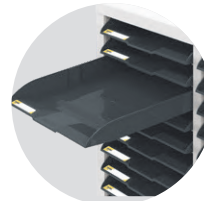

Drawer stop design



	A4L	A4M	A4A
Model No.			
Outer Dimensions	W257xD346xH78	W257xD346xH52	W260xD350xH50
Inner Dimensions	W251xD327xH72	W251xD327xH46	W245xD320xH46
Materials	PS		ABS



A4L-104

W284xD348xH360

Drawer : A4L x 4



A4A-106

W284xD348xH360

Drawer : A4A x 6



A4L-204P

W586xD348xH380

Drawer : A4L x 4



A4M-212

W586xD348xH380

Drawer : A4M x 12



A4L-220

W596xD348xH880

Drawer : A4L x 20



A4A-345

W880xD348xH880

Drawer : A4A x 45



A4M-345

W880xD348xH880

Drawer : A4M x 45



A4LM-32418

W880xD348xH1060

Drawer : A4L x 24
A4M x 18



A4A-345D

W940xD405xH945

Drawer : A4A x 45
Handle with lock







A4L-330D

W940xD405xH945

Drawer : A4L x 30
Handle with lock

Unit of Measurement : mm

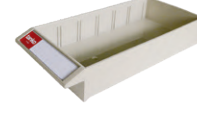

TKI Parts Cabinet

TKI-1	TKI-1-1	TKI-1-2	TKI-2	TKI-2-1
				
PS+ABS	ABS	PS	PS	ABS
Outer Dimensions : W120xD240xH70 Inner Dimensions : W114xD212xH65			Outer Dimensions : W100xD220xH52 Inner Dimensions : W90xD192xH47	
10kg load capacity	10kg load capacity	6kg load capacity	5kg load capacity	10kg load capacity

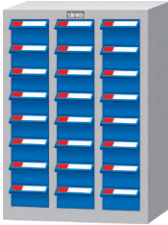
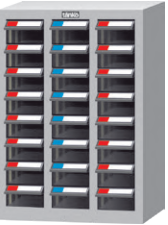
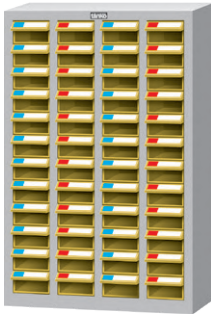
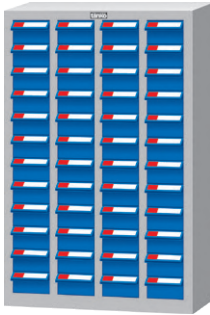
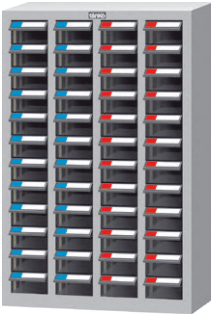

Each drawer includes one divider.
PS drawers are not suitable for oily items

					
TKI-1308	TKI-1308-1	TKI-1308-2	TKI-1412	TKI-1412-1	TKI-1412-2
Drawer : TKI-1 x 24	Drawer : TKI-1-1 x 24	Drawer : TKI-1-2 x 24	Drawer : TKI-1 x 48	Drawer : TKI-1-1 x 48	Drawer : TKI-1-2 x 48
W450xD242xH650			W600xD242xH940		

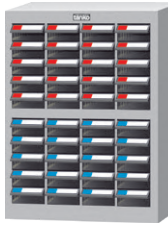
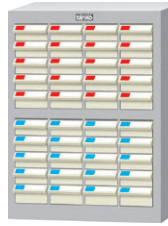
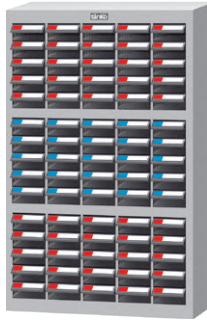
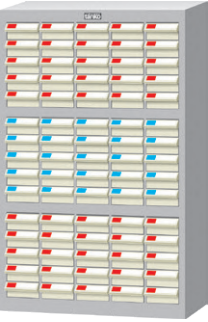
					
TKI-2405	TKI-2405-1	TKI-2410	TKI-2410-1	TKI-2515	TKI-2515-1
Drawer : TKI-2 x 20	Drawer : TKI-2-1 x 20	Drawer:TKI-2 x 40	Drawer:TKI-2-1 x 40	Drawer : TKI-2 x 75	Drawer : TKI-2-1 x 75
W460xD230xH310			W475xD230xH650		W580xD230xH940



TKI-1412D Drawer : TKI-1 x 48 Handle with lock	TKI-1412D-1 Drawer : TKI-1-1 x 48 Handle with lock	TKI-1412D-2 Drawer : TKI-1-2 x 48 Handle with lock
W645xD295xH1000		

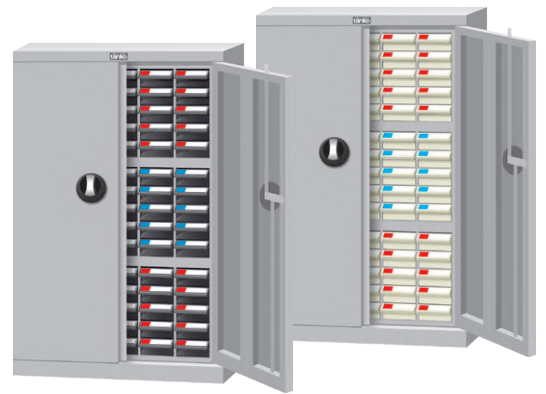

TKI-2515D Drawer : TKI-2 x 75 Handle with lock	TKI-2515D-1 Drawer : TKI-2-1 x 75 Handle with lock
W645xD295xH1000	

CEA/CEH Parts Cabinet

CEA	CEH
-----	-----



PS+ABS	
Outer Dimensions : W164xD282xH76 Inner Dimensions : W151xD253xH72	Outer Dimensions : W120xD238xH70 Inner Dimensions : W107xD213xH66
10kg load capacity	

Each drawer includes one divider.

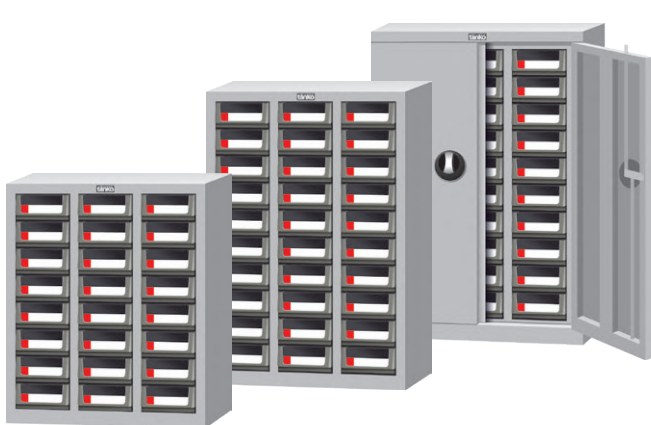

CEA-324 Drawer : CEA x 24 W600xD283xH720	CEA-330 Drawer : CEA x 30 W600xD283xH880	CEA-330D Drawer : CEA x 30 Handle with lock W640xD340xH925
---	---	--



CEH-324 Drawer : CEH x 24 W450xD240xH650	CEH-448 Drawer : CEH x 48 W600xD240xH940	CEH-448D Drawer : CEH x 48 Handle with lock W645xD295xH1000
---	---	---

Parts Cabinet

RB Parts Cabinet

 PATENTED



TB-1016

PP+PS

Outer Dimensions : W160xD450xH117
Inner Dimensions : W120xD385xH98

10kg load capacity

Each drawer includes one divider.



RB-530

Drawer : TB-1016 x 30

W900xD500xH900

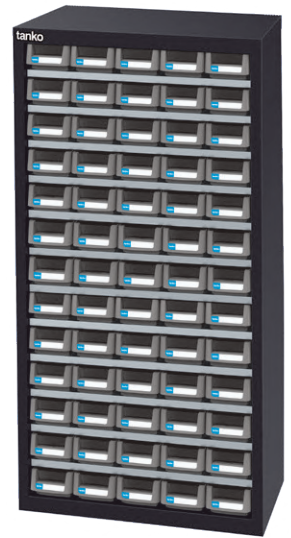

RB-565

Drawer : TB-1016 x 65

W900xD500xH1800

RM Parts Cabinet



TR-4116

ABS+PS

Outer Dimensions : W168xD415xH105
Inner Dimensions : W142xD373xH97

10kg load capacity

Each drawer includes one divider.



RM-309

Drawer : TR-4116 x 9

W560xD420xH468



RM-515

Drawer : TR-4116 x 15

W900xD420xH468



RM-318

Drawer : TR-4116 x 18

W560xD420xH880

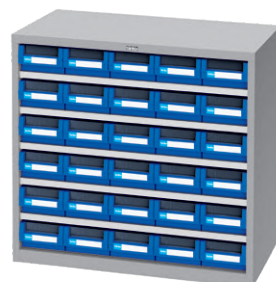

RM-530

Drawer : TR-4116 x 30

W900xD420xH880

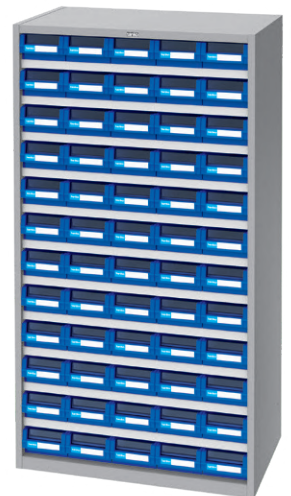

RM-560

Drawer : TR-4116 x 60

W900xD420xH1760

Tilt Out Bin



PC bins are suitable for oily items. 50° tilt out angle.



Can be applied to perforated boards with optional clips.



Bins are removable for easy access, refilling and cleaning.

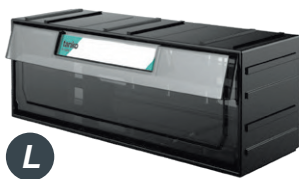

L

TC-111

W300xD98xH112.5

Drawer : W274xD62xH70

5kg load capacity

12 pcs / CTN
with colored label



M

TC-112

W300xD98xH112.5

Drawer : W126xD62xH70

3kg load capacity

12 pcs / CTN
with colored label



S

TC-113

W300xD98xH112.5

Drawer : W77xD62xH70

2kg load capacity

12 pcs / CTN
with colored label

Team Case

PS drawers are not suitable for oily items

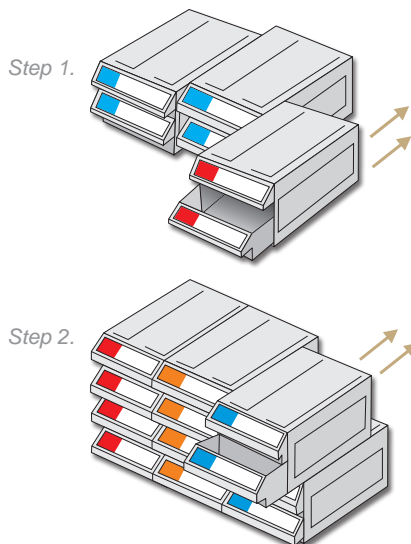

TKI-301

Outer Dimensions : W128xD195xH86

Drawer : W111xD168xH75

12 pcs / CTN
with colored label

TKI-302

Outer Dimensions : W128xD195xH86

Drawer : W111xD168xH35

12 pcs / CTN
with colored label

TKI-304

Outer Dimensions : W128xD195xH86

Drawer : W50xD168xH35

12 pcs / CTN
with colored label

TA Team Bin



Streamline shape

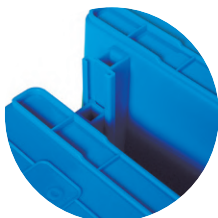

Side Link Slots



Supporting Poles



Colored Label



Hanger Function



TA-112

Outer Dimensions : W123xD180xH77
Inner Dimensions : W94xD133xH69

50 pcs / CTN

Supporting poles and colored label included

Has hanger function



TA-115

Outer Dimensions : W153xD250xH127
Inner Dimensions : W119xD191xH119

36 pcs / CTN

Supporting poles and colored label included

Has hanger function



TA-120

Outer Dimensions : W203xD350xH157
Inner Dimensions : W153xD276xH149

18 pcs / CTN

Supporting poles and colored label included



TA-154

Outer Dimensions : W203xD450xH180
Inner Dimensions : W148xD367xH172

12 pcs / CTN

Supporting poles and colored label included

Can be assembled with TA-155



TA-155

Outer Dimensions : W303xD450xH180
Inner Dimensions : W248xD367xH172

8 pcs / CTN

Supporting poles and colored label included

Can be assembled with TA-154

TKI Hanging Bin



Model No.	TKI-8301	TKI-8302	TKI-8303	TKI-8304	TKI-8305
Outer Dimensions	W105xD110xH50	W105xD140xH75	W105xD190xH75	W140xD220xH124	W140xD270xH125
Inner Dimensions	W86xD78xH45	W86xD100xH70	W86xD150xH70	W115xD151xH118	W115xD201xH118
Loading	3 kg	4 kg	4 kg	10 kg	10 kg
Qty	24 pcs / CTN	24 pcs / CTN	24 pcs / CTN	12 pcs / CTN	12 pcs / CTN
Color	● ● ●				
Items Included	Supporting poles and colored label included				

Has hanger function

